

ASSEMBLY INSTRUCTIONS

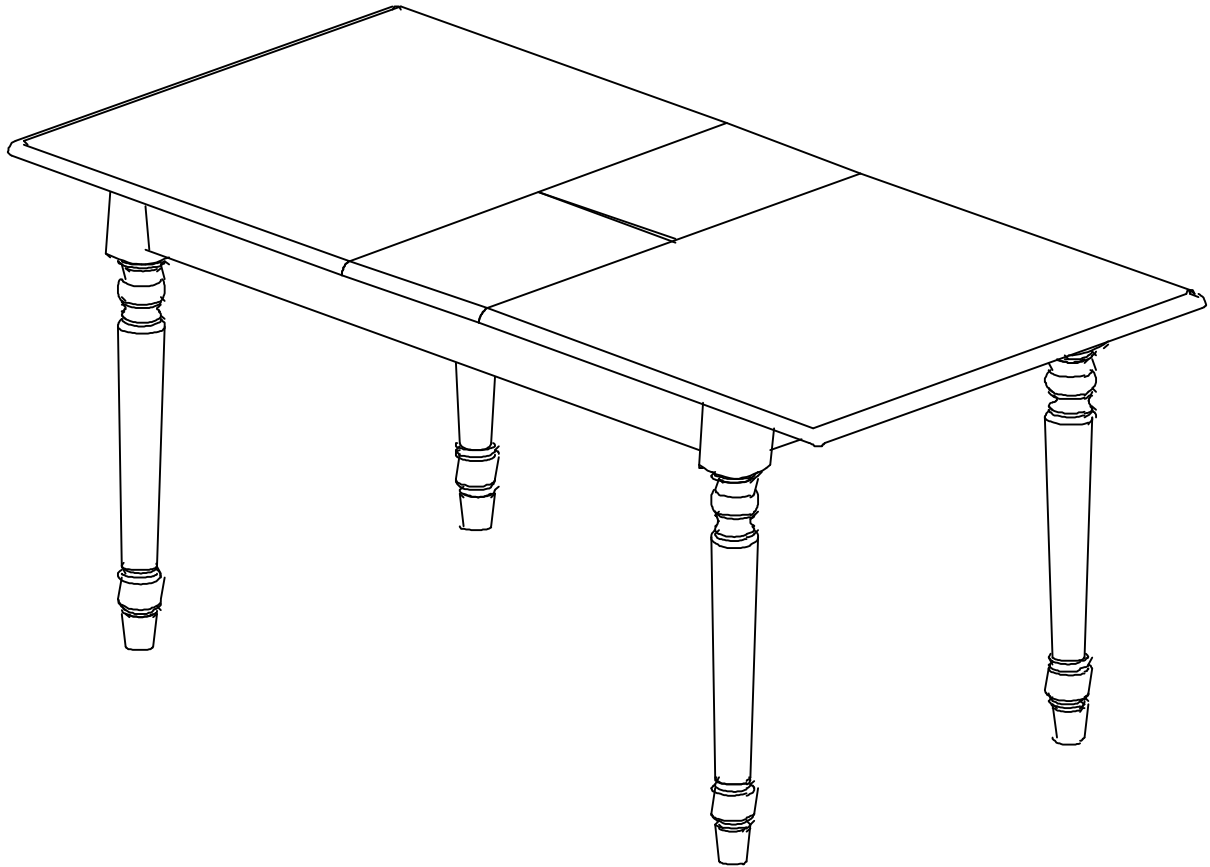

Description : BUTTERFLY LEAF EXTENSION
TABLE WITH TURNED LEG
Item No. : T-3660XB

BEFORE ASSEMBLY

Thank you for purchasing this quality product. This product has been designed for easy assembly and constructed for durability. All parts were checked prior to packaging to insure quality. Prior to beginning assembly, however, make sure all parts and hardware are included and free of obvious defect. If a part is missing or defective, please contact the store where purchased. If hardware is missing, or you need help with assembly, please call toll free 888-944-8396.

IMPORTANT NOTE:

- Place all wooden parts on a clean and smooth surface such as a rug or carpet to avoid the parts from being scratched.
- Remove all wrapping material, including staples & packing straps before you start to assemble.
- DO NOT tighten all screws and bolts until completely assembled.
- Keep all hardware parts out of reach of children.





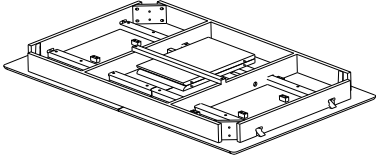
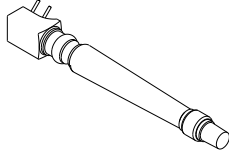

PARTS LIST

When unpacking, please be careful not to discard any parts with the packaging. Before continuing, please make sure you have the following parts:

NO	Description	Q'ty	Sketch	NO	Description	Q'ty	Sketch
A	Top	1		B	Leg	4	

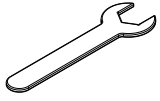
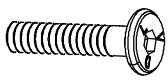
HARDWARE LIST

When unpacking, please be careful not to discard any parts with the packaging. Before continuing, please make sure you have all of the following hardware:

NO	Description	Q'ty	Sketch	NO	Description	Q'ty	Sketch
1	Flat washer ($\Phi 8.5 \times \Phi 19 \text{mm}$)	8		2	Lock washer ($\Phi 8.5 \times \Phi 13 \text{mm}$)	8	
3	Hexagon nuts (M8x13mm)	8		4	Wrench (M13mm)	1	
5	Short bolt (M6 x 35mm)	4		6	Lock washer ($\Phi 6.5 \times \Phi 11 \text{mm}$)	4	
7	Flat washer ($\Phi 6.5 \times \Phi 16 \text{mm}$)	4		8	Allen key (4x80mm)	1	

STEP 1

Twist the wood stopper, and attach to the Top (A) with bolt (5) and washers (6), and (7) as shown below. Tighten with the Allen key (8).

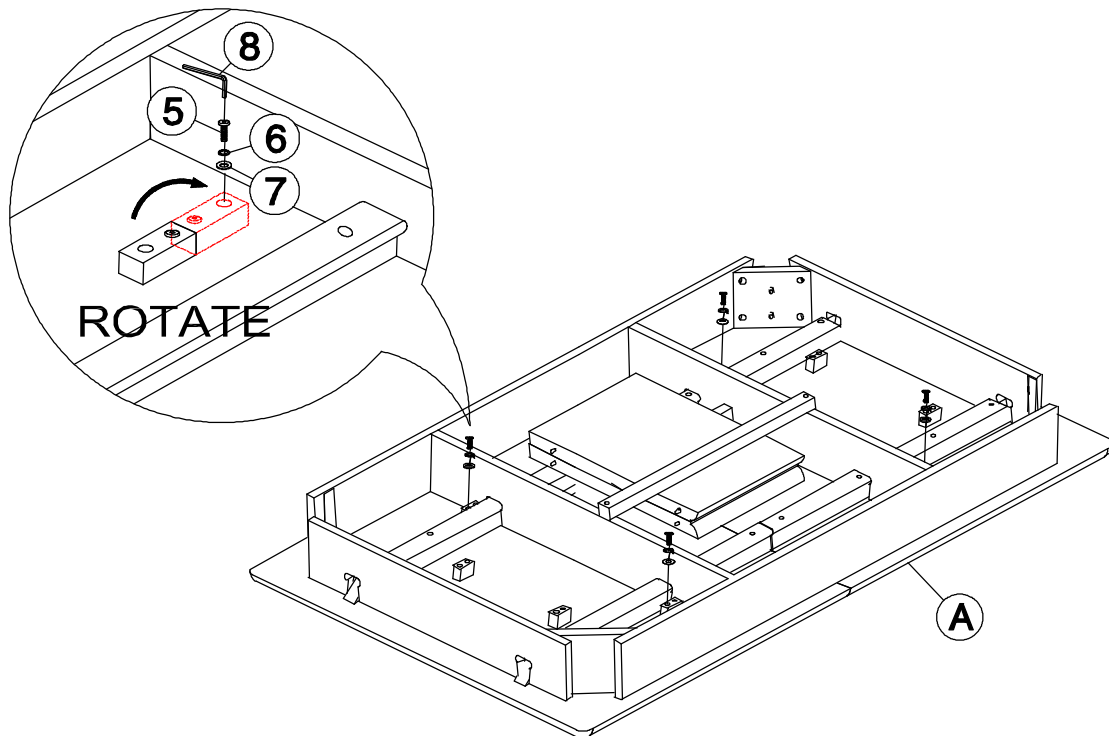

STEP 2

Attach legs (B) to top (A) as shown below, using washers (1) and (2), and nuts (3). Tighten with the wrench (4).

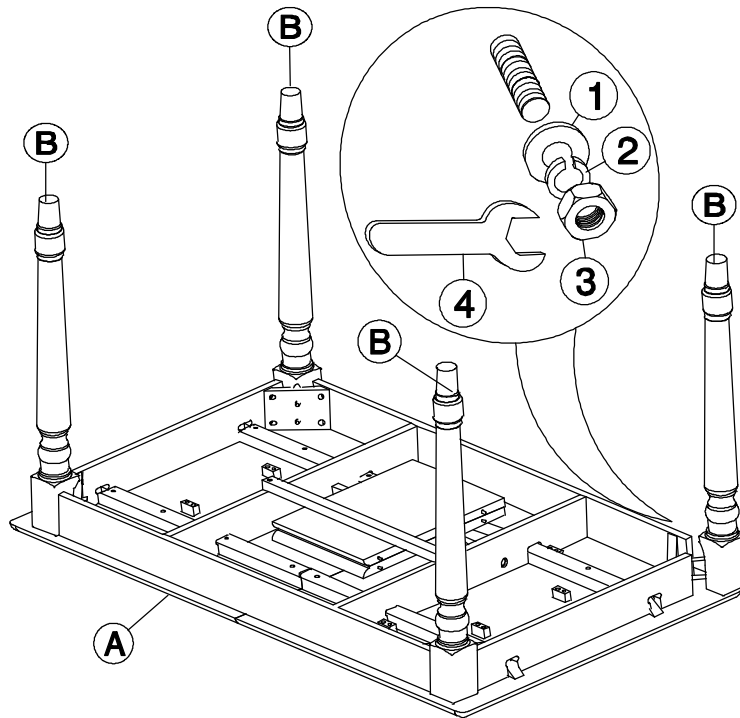

STEP 3

Place the table in an upright position, unlock the table top from both sides underneath of the top as shown below. Pull the 2 sides apart.

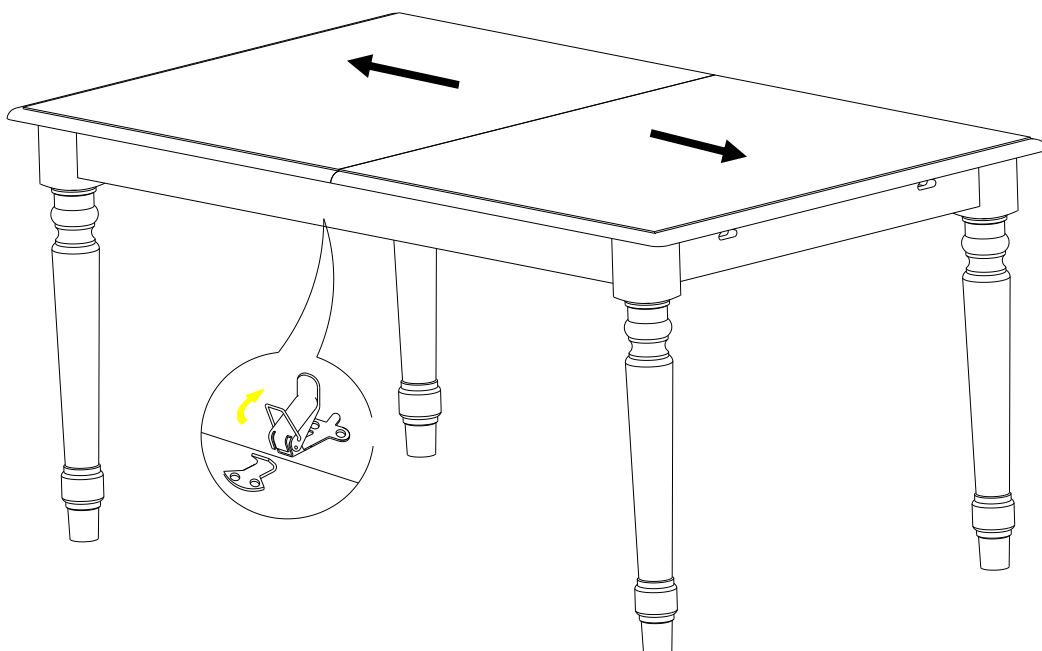

STEP 4

Fold the center leaf to store it underneath the table top, or leave it open as you choose. Lock the top as shown below.

